

VNA Master™

High Performance Handheld Vector Network Analyzer

MS2026B

5 kHz to 6 GHz

MS2028B

5 kHz to 20 GHz

The Ultimate Handheld Vector Network Analyzer
for Cable and Antenna Analysis Anytime, Anywhere

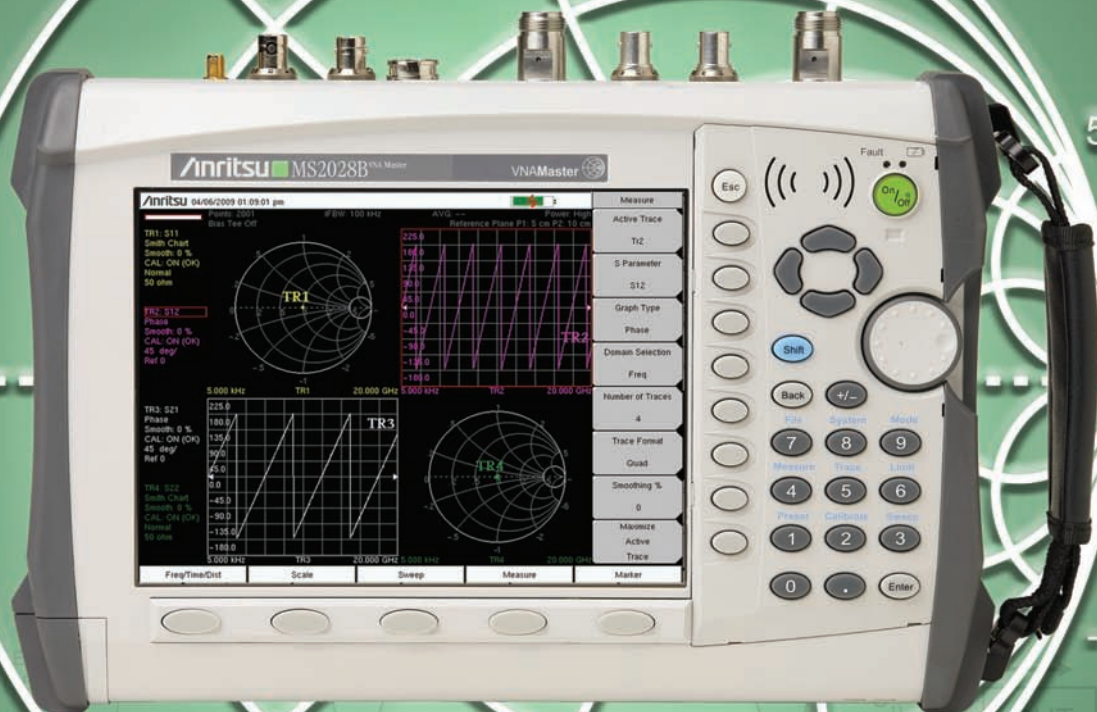

VNA Master™ – The Ultimate Handheld Tool for Two-Port Measurements Anytime, Anywhere

RF engineers and technicians in the field provide a valuable service as they support aerospace, defense, and general purpose RF and microwave systems around the world. They ensure radars on naval vessels are operational. They test antennas on military vehicles. They perform flight-line test on Air Force, Navy, and commercial jets. They maintain a whole world of wireless communication systems. They support VHF Omni-directional Range (VOR) in radio navigational systems. They ensure direction finding (DF) reconnaissance systems precisely pinpoint threats. They maintain short-range weather observatories.

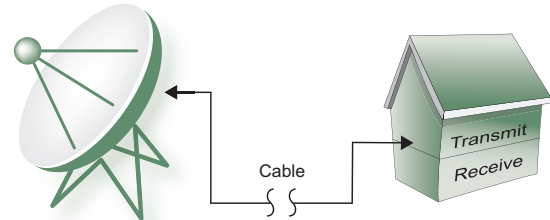

The RF and Microwave Spectrum is crowded with many wireless systems that provide critical services. In this illustration, a simplified block diagram of a typical wireless system is shown, which consists of antenna, cable, and transmit/receive capabilities.

Their jobs are formidable, and those intrepid installation and maintenance personnel are in dire need of portable measurement tools to quickly and precisely identify faults in the field on these systems. In a typical wireless system, they will be routinely faced with a wide variety of system elements that can cause failure in the overall system: antennas, cables, filters, multiplexers, amplifiers, isolators, circulators, switches, low noise amplifiers, and other sophisticated elements. Others will also be working on different RF/Microwave systems from the broadcast band to Ku-band radar. To further complicate matters, their bulky, AC-powered, and expensive bench instruments increase complexity and limit their mobility.

Anritsu introduces the industry's broadest frequency handheld solution to address these cable and antenna needs in the field: the MS202xB VNA Master with frequency coverage from 5 kHz to 20 GHz. Equally impressive, this broadband measurement tool offers the industry's first 12-term error correction algorithm in a truly handheld, battery-operated, rugged multi-function instrument.

The VNA Master easily replaces bulky and obsolete bench-top scalar and vector network analyzers with a more efficient-to-use handheld instrument so technicians can freely roam the sites they service. This freedom enables swift and precise measurements as they phase match cables, troubleshoot critical system faults, and perform routine installation and maintenance tasks anytime, anywhere.



You can replace bulky vector network analyzers with a truly portable version that is much more field friendly.

Feature	Benefit
Two-port vector network analysis to 20 GHz that supports both coaxial and waveguide connector types	Verify antennas, phase match cables, waveguides, and find problems using Distance-to-Fault (DTF)
True 2-port, 12-term error correction calibrations	Precisely measures all four S-parameters with a single connection
Fully reversing architecture with three receivers support fast measurements of 750 μ sec/point	Single connection reveals all four S-parameters with enough speed to tune filters in real-time or troubleshoot intermittent problems
Optional power monitor measurements (1 MHz to 20 GHz)	More accurately troubleshoot transmitters in the field using external detector
Optional high accuracy power meter, USB power sensors (50 MHz to 18 GHz)	Integrated power meter that rivals bench top power meters
Optional Vector Voltmeter (VVM) mode	Replace obsolete VVM, synthesizer, and external accessories with more turnkey solution, ideal for cable phase matching
Ergonomically designed controls	Easy-to-learn and easy-to-use for optimizing operator productivity
Handheld battery-operated microwave test solution	Freely roam the site without AC power

Introducing the VNA Master: High Performing, Modern Connectivity, and Reliability for Remote Measurements

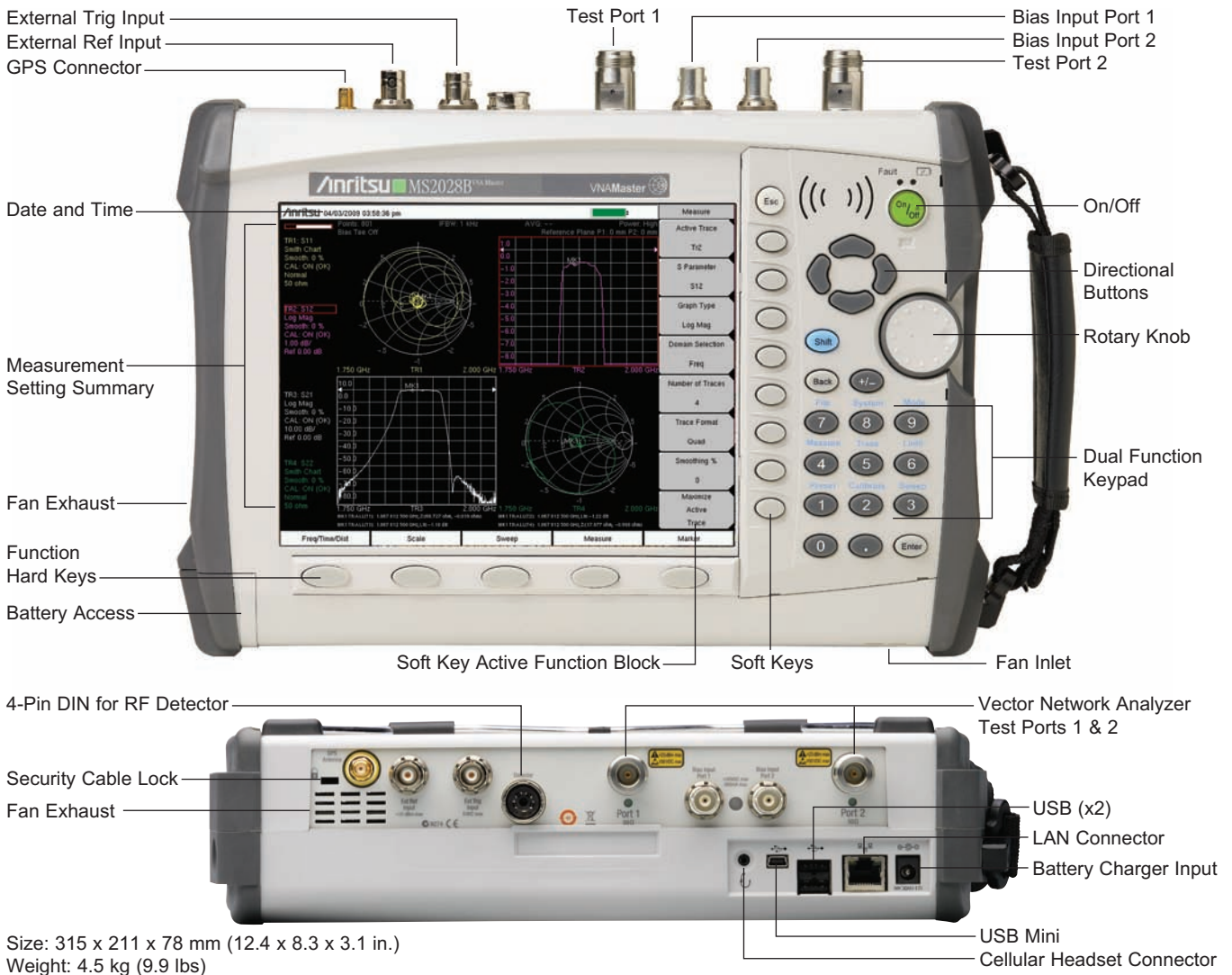

Standard Type-N Test Ports are fully reversible so that the component under test does not need to be reconnected when characterizing all four S-parameters. Precision K-connectors are optional on the MS2028B.

Feature	Benefit
Light weight (less than 4.5 kg. including battery) and rugged design	Convenient operation anytime, anywhere
Display results in user-defined single, dual, tri, and quad formats while simultaneously viewing all four S-parameters	Conduct measurements with hands-free operation and/or configure results with almost unlimited flexibility to satisfy your preferences
Default N-type test port connectors; no-cost option available for precision K connector on MS2028B (not field replaceable)	Choose N-type for rugged use and K connector for precision applications to 20 GHz
Soft keys, directional buttons, and rotary knob	Tactile feedback enables precise control of instrument settings
LAN and USB 2.0 (full-speed) connections	Latest connections for data transfer, data archival, and firmware upgrades
Rechargeable and field replaceable Li-Ion Battery	Conduct measurements for >2 hours on a single charge
1 GB storage, plus Optional Secure Data Storage	Store and easily access more than 4,000 traces and 4,000 measurements setups, including optional external-only storage for secure environments
Remote programming via Ethernet	Increase productivity by automating repetitive or operator intensive tasks
Large 8.4 in. full-color TFT display screen	At-a-glance results for easy readouts, whether inside or outdoors

VNA Master is Truly a Handheld Vector Network Analyzer!

The VNA Master is the world's first truly portable two-port fully-reversing Vector Network Analyzer (VNA). The ruggedized technology inside the B-series is optimized for the precision S-parameter measurements of cables, antennas, and filters. Why use an expensive bench VNA when a lower-cost portable version is now available?

The precision in the VNA originates from an architecture that measures not only magnitude, but phase. For this reason, a calibration is required to establish the reference plane and to correct for system errors before measurements. To help differentiate the results from scalar measurements, the VNA displays S-parameters, where the subscript denotes transmit and reflected signals for the measurement. For more information on S-parameters, please refer to our Primer on Vector Network Analysis (part number 11410-00387).

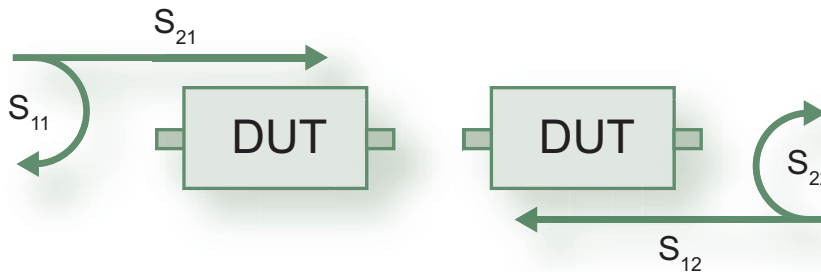

There are four S-parameters for a two-port device under test (DUT): S_{11} , S_{21} , S_{22} , and S_{12} . On the left, the forward transmission from Port 1 measures S_{11} and S_{21} . On the right, the reverse transmission from Port 2 measures S_{22} and S_{12} . Each of these four S-parameters has both magnitude and phase terms that can be displayed in a variety of popular trace formats.

The VNA Master has an architecture that automatically measures these four S-parameters with a single connection. There are three receivers so the forward sweep from Port 1 simultaneously yields S_{11} and S_{21} and the reverse sweep from Port 2 simultaneously yields S_{22} and S_{12} . Thus, as shown below, the four S-parameters for a two-port DUT require two sweeps, both forward and reverse transmission. With a single connection, the VNA Master provides both precision measurements and hands-free operation.

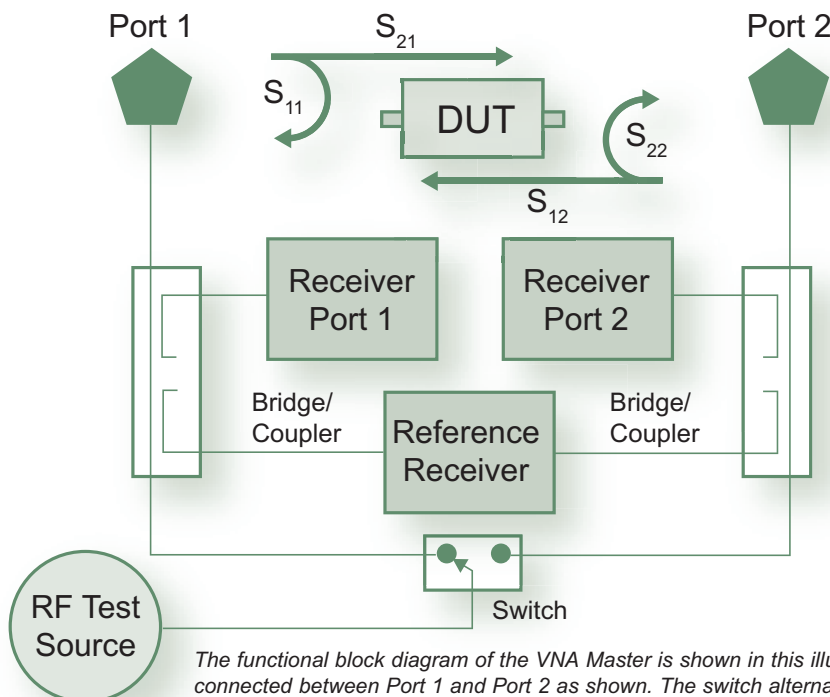

The functional block diagram of the VNA Master is shown in this illustration. The DUT is connected between Port 1 and Port 2 as shown. The switch alternates the source between forward and reverse transmission sweeps so all four S-parameters are measured with in a single connection. With three receivers, the MS202xB only needs two sweeps to measure S-parameters so real-time display updates in excess of 1 ms/point are available for tuning filters and isolating faults in the field.

Applications: Cable and Antenna Analyzer (1-Port)

Performance of all RF and Microwave systems is crucially dependent on a variety of components, especially those subject to the long term effects of weather and aging. The cables, antennas, filters, and interconnects degrade over time due to corrosion, water damage, and the aging process. Portable tools are needed to detect degradations before they result in system failures. The MS202xB offers a portable way to use S-parameters on coaxial and waveguide components to identify these types of degradations sooner than any other approach.

The first measurement on site usually involves “shooting” the cable and antenna system (from the ground) to verify performance. For this first step, a simple measurement of return loss (S_{11}) will reveal whether this critical physical link is in need of repair. Set the frequency range, conduct a quick Open-Short-Load (OSL) calibration, connect for measurement, and determine whether or not a fault exists.

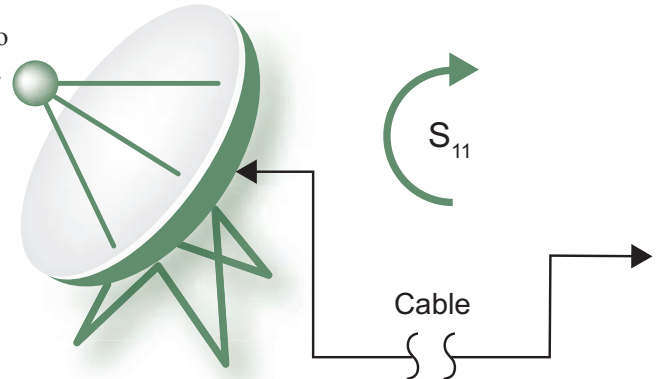

Isolate the cable and antenna portion of the system for a quick S_{11} measurement to reveal degradations or faults.

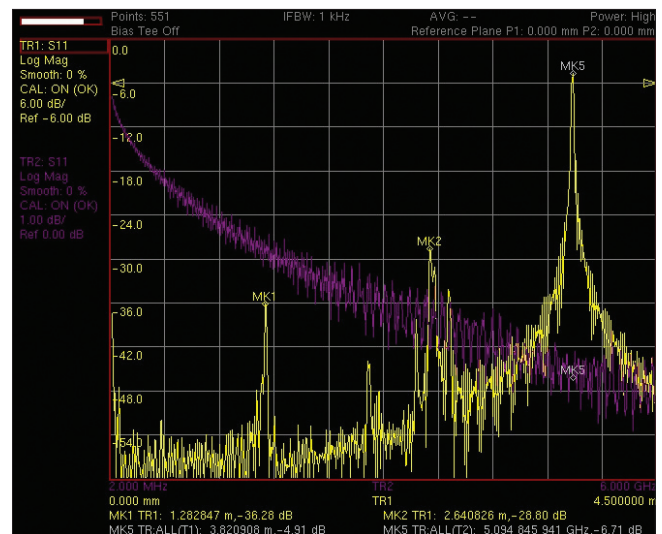
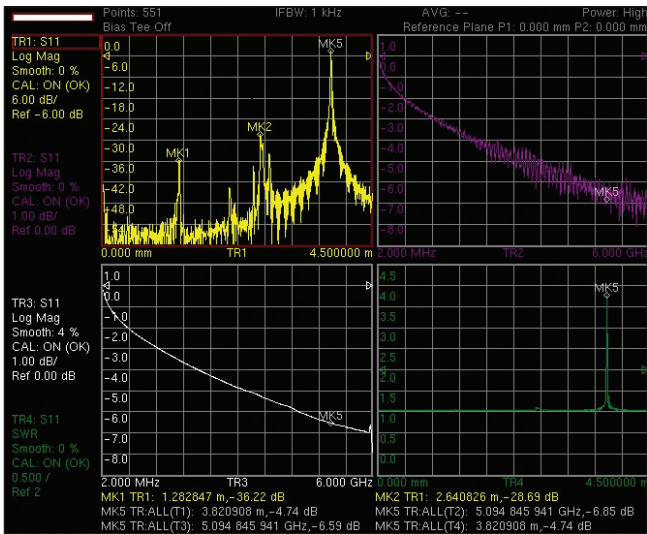

The VNA Master has a flexible display that can simultaneously view S_{11} , as distance-to-fault (log magnitude), return loss, cable loss with smoothing (Log Mag $|S_{11}|$ / 2), and distance-to-fault (SWR). On the left is a four trace display in quad format. On the right is a two trace display in single overlay format. A single keystroke toggle can maximize and minimize individual traces for additional viewing flexibility.

Once the return loss (S_{11}) is measured, it’s easy to format the display for your preferences. With optional time domain analysis applied, the swept frequency response can also reveal discontinuities versus distance (or time). For best results, simultaneously overlay all the relevant results on the daylight viewable screen so you can keep your hands free for your maintenance activities.

The Limitation of 1-Port Techniques

The 1-port approach is an ideal technique for deployed cable measurements, but it does have a practical limitation in extracting insertion loss from the S_{11} measurement. The actual return loss of the cable and connectors can obscure the extraction of insertion loss and this is more of an issue as insertion losses increase. To calculate cable loss, the far end of the cable is shorted and the resulting S_{11} return loss measurement is divided by two (i.e., Log Mag $|S_{11}|$ / 2) to compensate for the roundtrip in the cable. As a practical tip, you need to be careful interpreting S_{11} when it is greater than 15 dB (or cable loss greater than 7.5 dB). At these levels the uncertainties are in the $\pm 1-2$ dB range even for a well matched cable. This threshold is easy to exceed for long cable lengths, especially cables operating at higher frequencies.

For longer cables or more precise measurements you will need to use a 2-port setup in order to improve uncertainties.

Applications: Distance-To-Fault (DTF) using Optional Time Domain Analysis

Time Domain Analysis is a powerful tool to analyze cables for faults, including minor discontinuities that may occur due to a loose connection, corrosion, or other aging effects. By using Frequency Domain Reflectometry (FDR), the VNA Master uses operational frequencies (instead of DC pulses from TDR approaches) to more precisely identify discontinuities. Using optional time domain analysis, the VNA Master converts S-parameters from frequency domain into distance (or time) domain on the horizontal display axis. Connect a reflection at the opposite end of the cable and the discontinuities appear versus distance to reveal any potential maintenance issues. When access to both ends of the cable is convenient, a similar time domain analysis is available on transmission measurements.

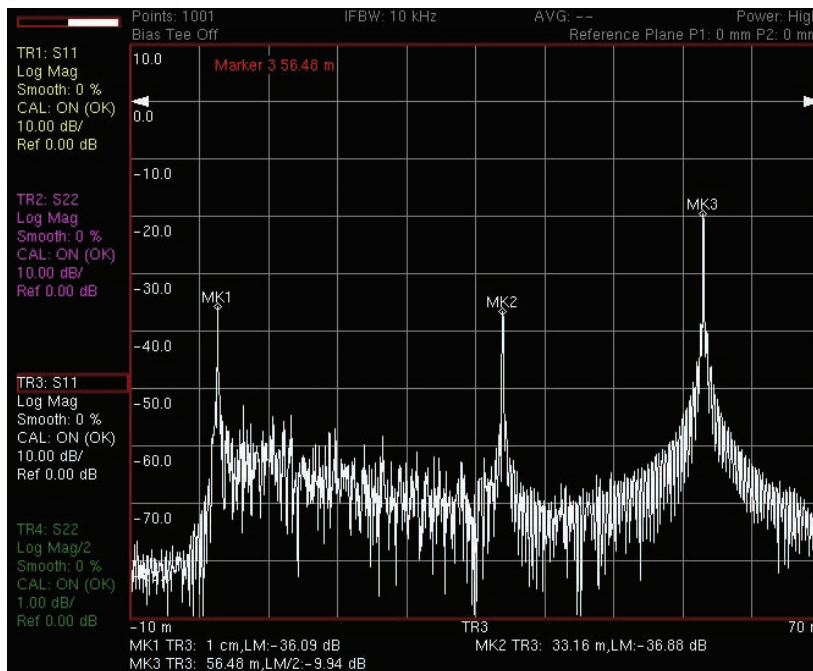
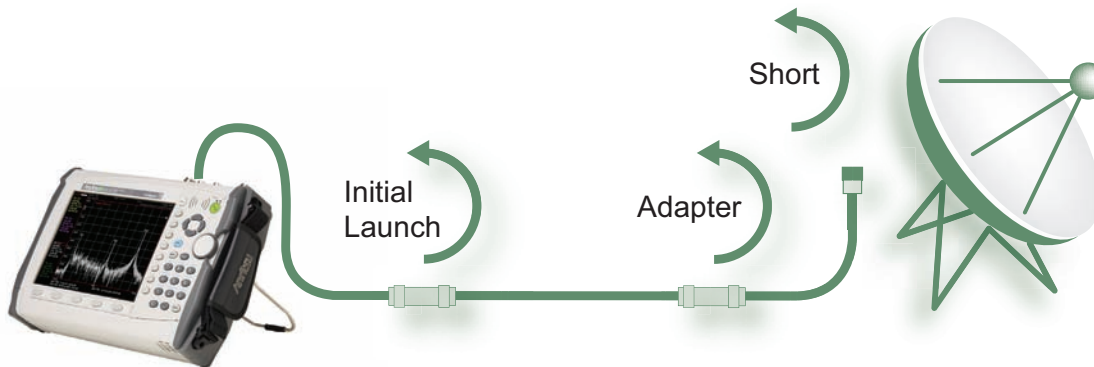

The above illustration shows a typical cable measurement scenario with an adapter between the near and far end of the cable. With a short on the far end, the VNA Master can convert frequency domain results to corresponding distance (or time) domain readout. Moving left to right, we can see the initial launch (MK1), the adapter (MK2), and the short at the far end of the cable (MK3). Using time domain analysis, it is easy to interpret the discontinuities as normal or faults by simply looking at the location and amplitude of the peaks.

Optional time domain analysis will improve your productivity with displays of the cable in terms of discontinuities versus distance. This readout can then be compared against previous measurements in order to determine whether any degradations have occurred since installation (or the last maintenance activity). More importantly, you will know precisely where to go to fix the problem and so minimize or prevent downtime of the system.

Applications: Precision Two-Port Transmission Measurements

Other handheld tools offer two-port measurement capabilities; however, their approach is to use a scalar spectrum analyzer for the far end transmission measurement. An easy way to identify the architecture is to look at the transmission measurement accuracy (or uncertainty). By using magnitude and phase, the Anritsu VNA Master offers nearly ten times the accuracy of these other tools.^[1] The additional precision is ideally suited for verifying the transmit and receive path in modern wireless, aerospace, and defense systems operating at RF and microwave frequencies.

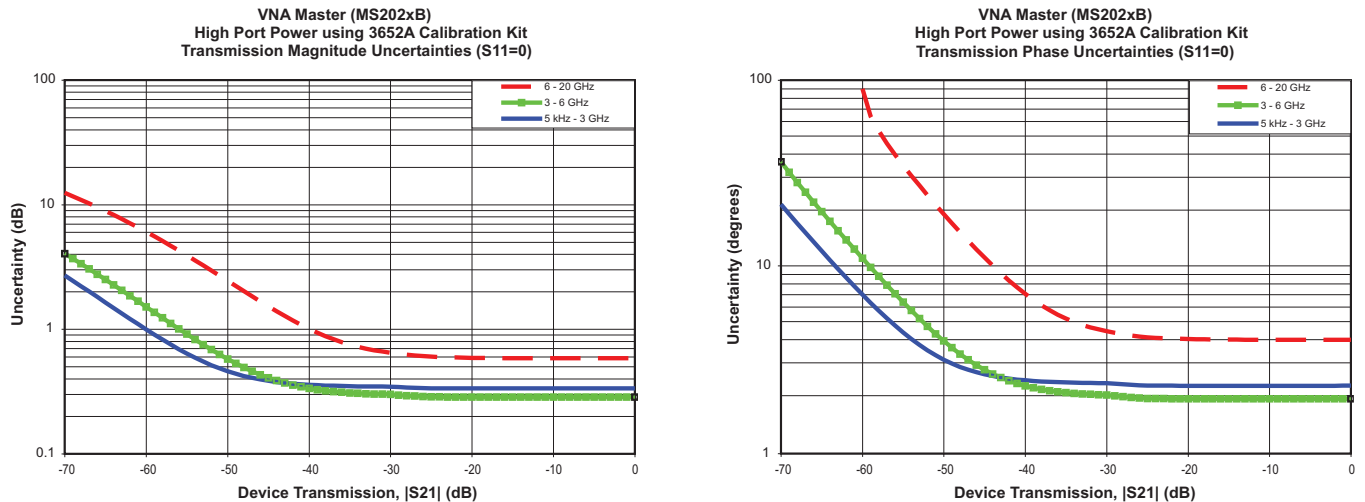

These two transmission uncertainty curves, magnitude on the left and phase on the right, describe the MS202xB's worst-case uncertainties for S_{21} transmission measurements when using the high port power setting. Each trace represents the frequency range described in the legend. The transmission magnitude uncertainties for S_{21} measurements between 0 and 30 dB is less than 0.6 dB. Similarly, the transmission phase uncertainties for S_{21} measurements between 0 and 30 dB is less than 4°. The typical uncertainties are nearly 10x better than scalar based transmission measurements.

The measurement of two-port devices (e.g., filters) on site is becoming more common to mitigate co-location issues and for compliance reasons. To optimize the coverage (or range) of a communication system, the transmit and receive paths need signal separation components to prevent interference, to comply with industry spectrum masks, and to satisfy dynamic range needs.

The precision of the VNA Master is ideally suited for measuring these types of low-loss signal separation devices. These include isolators, circulators, filters, and duplexers. Verifying key passband specifications requires measurement of match, insertion loss, group delay, isolation, and flatness. Simultaneous overlay of results is desired for tuning tasks since interactions between match and transmission characteristics are involved. VNA Master has the necessary performance and features to verify the transmission (i.e., 2-port) characteristics of these devices on site.

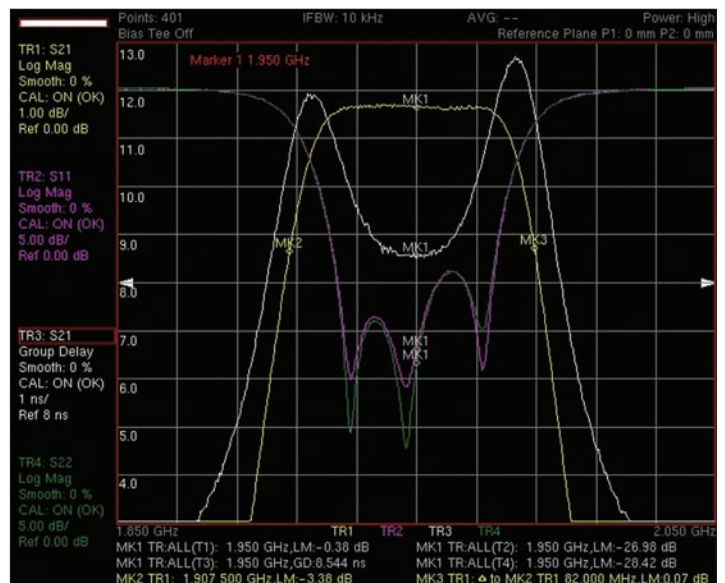

A two-port filter measurement is shown using a four trace overlay feature. This measurement reveals that the filter is well matched, the passband flatness is acceptable, and the group delay is within specification. A portable tool with fast sweeps of 750 μ sec/point can even offer real-time tuning of this device on site.

^[1] For frequencies greater than 1 GHz, other portable spectrum analyzer tools will typically specify 1-2 dB amplitude accuracy, excluding mismatch effects. In contrast, the VNA Master offers typical S_{21} uncertainties of ± 0.2 dB to 20 GHz, a difference of nearly ten times in accuracy!

Applications: Phase Match Cables Using Optional Vector Voltmeter Mode

There are many wireless systems that utilize multiple antennas and equal length cables to control radiation patterns. One such system is the instrument landing system (ILS) found at the end of every airport runway. Its purpose is to aid aircraft landings during inclement weather. Another system is the VHF Omni-directional Range (VOR) that provides ground-based navigational reference for aircraft. Phased array radar systems for defense applications also rely on this principle to detect and track threats. Failure in one cable can cause serious degradation, and in some cases even failure, of the overall system. For normal operation, these wireless systems depend on equal-length cables to supply the correct signal phase to each appropriate antenna element, as shown in the illustration at right.

The term “phase match” is interchangeable with “equal electrical length” and describes the traditional technique whereby cables are measured against each other at the operational frequency. The difference in degrees, a value proportional to the wavelength, determines whether or not the cables are phase matched and subsequently equal length.

Installation, deployment, and maintenance require instrumentation with phase measuring capabilities at the operational frequency. A vector voltmeter has traditionally been selected for ease-of-use, but now that this instrument is obsolete, a vector network analyzer tool can replace it.

The VNA Master provides frequency coverage, two-port S-parameter architecture, and portability to precisely phase match cables anytime, anywhere.

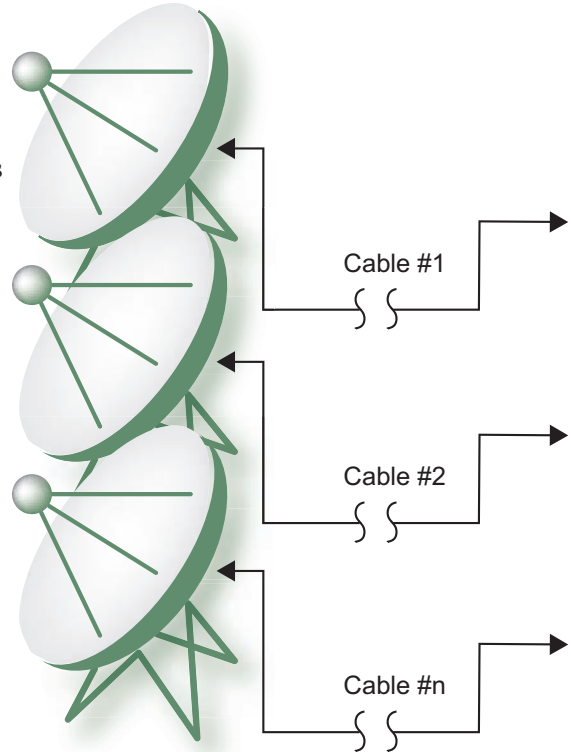

More sophisticated systems require phase matched cables to individual antenna elements for normal operation. Failure in an individual cable can lead to serious performance degradation (or failure) of the overall system.

VECTOR VOLTMETER		
Freq: 10.000 GHz	CAL:ON	
-0.01	REL	dB
-0.15	REL	deg
Reference(REL)	-1.68 dB	173.6 deg
Type: Return	Format: dB	

This is the popular CW display for phase matching two cables at 10 GHz. In this CW display, the large font of the relative (REL) magnitude & phase for the second cable is easily viewable during trimming operations. Furthermore, the magnitude & phase of the reference cable is provided underneath for additional convenience.

VECTOR VOLTMETER TABLE				
Freq: 10.000 GHz		CAL:ON		
Reference(REL)	-1.68 dB	173.65 deg		
Cable	Amp	REL Amp	Phase	REL Phase
1	-1.67 dB	0.00 dB	173.26 deg	-0.39 deg
2	-1.66 dB	0.01 dB	173.42 deg	-0.23 deg
3	-1.68 dB	0.00 dB	173.22 deg	-0.43 deg
4	-1.68 dB	-0.01 dB	173.20 deg	-0.45 deg
5	-1.68 dB	0.00 dB	173.21 deg	-0.44 deg
6	-1.67 dB	0.01 dB	173.35 deg	-0.30 deg
7	-1.68 dB	0.00 dB	173.17 deg	-0.48 deg
8	0.00 dB	0.00 dB	0.00 deg	0.00 deg
9	0.00 dB	0.00 dB	0.00 deg	0.00 deg
10	0.00 dB	0.00 dB	0.00 deg	0.00 deg
11	0.00 dB	0.00 dB	0.00 deg	0.00 deg
12	0.00 dB	0.00 dB	0.00 deg	0.00 deg
Type: Return		Format: dB		

For applications with more than two cables, the table view is even more convenient for simultaneously viewing (and documenting) phase matching results for up to twelve cables.

Applications: Waveguide Measurements

The VNA Master supports N, K, TNC and up to four user-defined coaxial connections. For waveguide, add an optional external coaxial to waveguide adapter (available in a variety of popular flange types) to conduct S-parameter measurements. Calibrations require using available waveguide calibration components (instead of coaxial open, short, and load standards). For additional accuracy, the MS202xB includes waveguide dispersion correction for distance measurements to compensate for different propagation speeds of different wavelengths.



Frequency Band	Popular Waveguide Standards	Frequency Range (GHz)
E band	WR229, WG11A	3.30 to 4.90
G band	WR187, WG12	3.95 to 5.85
C band	WR137, WG14	5.85 to 8.20
H band	WR112, WG15	7.05 to 10.00
X band	WR90, WG16	8.2 to 12.4
Ku band	WR75, WG17	10.00 to 15.00
Ku band	WR62, WG18	12.4 to 18.0
K band	WR42, WG20	18.0 to 26.5

The VNA Master also supports waveguide measurement of popular flange types by using a coaxial to waveguide adapter and available waveguide calibration components as shown in this figure. Simply choose the waveguide adapter and calibration standards that support the flange type of your popular waveguide standard. In all other respects, the measurements are as straightforward as selecting an S-parameter and formatting the traces for your display preferences.

Soft Carry Case Offers Easy Access and Protection

A standard accessory of the VNA Master is the soft carry case that allows you to carry your instrument on site with the available shoulder strap. Although the primary benefit is to protect your capital equipment investment, this case is also designed to offer convenient use in the field environment. The already rugged design of the VNA Master along with the soft carry case ensures that your VNA Master will reliably serve you for many years.



This is the storage and maximum protection configuration, which utilizes a cover to protect the screen and interconnects.

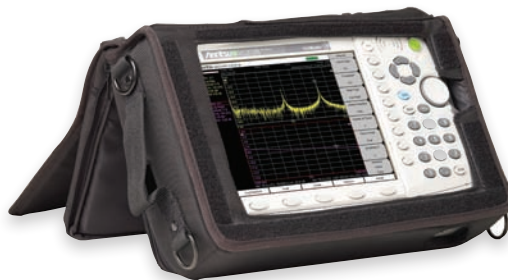

This shows the working configuration where the case doubles as a tilt-bail for more convenient hands-free operation.



This shows how the case has easy access to test port and other interconnects. A separate flap on the top protects the Ethernet, USB, and power supply connections.

Extend the Capabilities with Valuable Options

Time Domain Analysis (Option 0002)

The VNA Master can display the S-parameter measurements in the time or distance domain using this popular analysis mode. The broadband frequency coverage coupled with 4001 data points means you can measure discontinuities both near and far with clarity unprecedented in a hand held tool. With this option, you can simultaneously view S-parameters in frequency, time, and distance domain to quickly identify faults in the field. Further enhance the Distance-to-Fault (DTF) results by compensating for loss and relative propagation velocity (for cables) or cutoff frequency and dispersion (for waveguides).

Side lobes are inherent by-products of time domain analysis. They can distort DTF results, especially when simultaneously measuring both small and large discontinuities in close proximity to each other. To more easily interpret DTF results, the VNA Master offers the following windowing selections to help optimize results (in increasing side lobe reduction order): rectangular, nominal, low, and minimum side lobe. These windowing selections trade-off side lobe level with resolution by smoothing out sharp transitions caused by the selected start and stop frequencies.

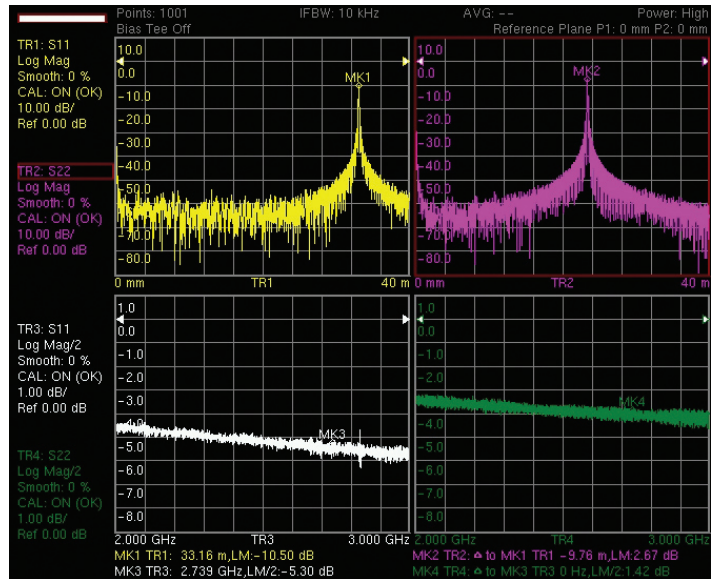

Optional time domain analysis offers trace selections for the horizontal axis in frequency, distance, or time scales. This screen simultaneously shows distance-to-fault and cable loss (Log Mag|S₁₁| / 2) for S₁₁ and S₂₂.

Power Monitor (Option 0005)

Transmitter measurements in the field are possible when using this VNA Master software mode with a separately purchased Anritsu 560 series detector. A variety of detectors are available. The popular 560-7N50B covers 10 MHz to 20 GHz with a measurement range of -50 to +20 dBm with better than 0.5 dB flatness to 18 GHz. After zeroing the detector to ensure accuracy at low power levels, the software offers intuitive operation for absolute and relative readouts in dBm or Watts.



The easy-to-view Power Monitor option offers convenient transmitter measurements in the field.



For secure environments, VNA Master will only use external USB memory as an external drive for storage when configured with Option 0007. Internal memory is disabled for data storage.

Secure Data Operation (Option 0007)

For highly secure data handling requirements, this software option prevents the storing of measurement setup or data information onto any internal file storage location. Instead, setup and measurement information is stored ONLY to the external USB memory location. A simple factory preset prepares the VNA Master for transportation while the USB memory remains behind in the secure environment. Once configured for secure data operation, the VNA Master cannot be switched between secure and non-secure operation by the user.

Bias Tee (Option 0010)

For tower mounted amplifier tests, the MS202xB series when configured with the optional internal bias tees can supply both DC and RF test signals on the center conductor of the cable during measurements. In addition, the VNA Master can supply internal voltage control from +12 to +32V in 0.1V steps up to 450 mA. To extend battery life, an external power supply can substitute for the internal supply by using the external bias inputs instead. Both test ports can be configured to supply voltage via this integrated bias tees option.

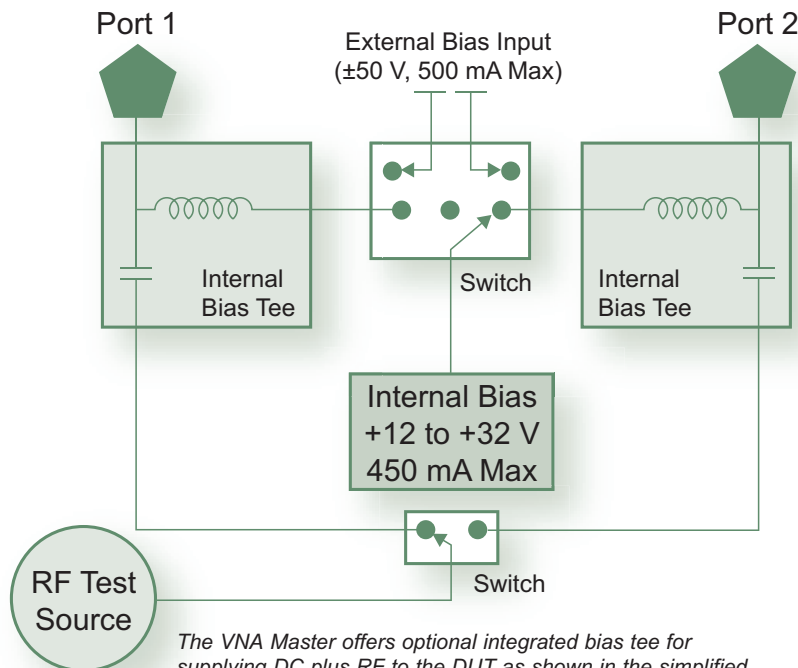

The VNA Master offers optional integrated bias tee for supplying DC plus RF to the DUT as shown in the simplified block diagram. Connectivity is also provided for external supply (instead of internal) to preserve battery consumption.

Extend the Capabilities with Valuable Options (Continued)



Optional K(f) test port connectors are available for precision measurements to 20 GHz.

K(f) Test Port Connectors (Option 0011), Available on MS2028B only

For precision requirements to 20 GHz, this no-cost option changes the standard N-type test port connectors to rugged K connectors. This is not field replaceable so make sure to specify your preference when ordering.

Vector Voltmeter (Option 0015)

A phased array system relies on phase matched cables for required performance. For this class of application, the VNA Master offers this special software mode to simplify phase matching cables at a single frequency.

The similarity between the popular vector voltmeter and this software mode ensure minimal training is required to phase match cables. Operation is as simple as configuring the display for absolute or relative measurements.

The easy-to-read large fonts show either reflection or transmission measurements using impedance, magnitude, or VSWR readouts. For instrument landing system (ILS) or VHF Omni-directional Range (VOR) applications, a table view improves operator efficiency when phase matching up to twelve cables.

The MS202xB solution is superior because the signal source is included internally, precluding the need for an external signal generator.

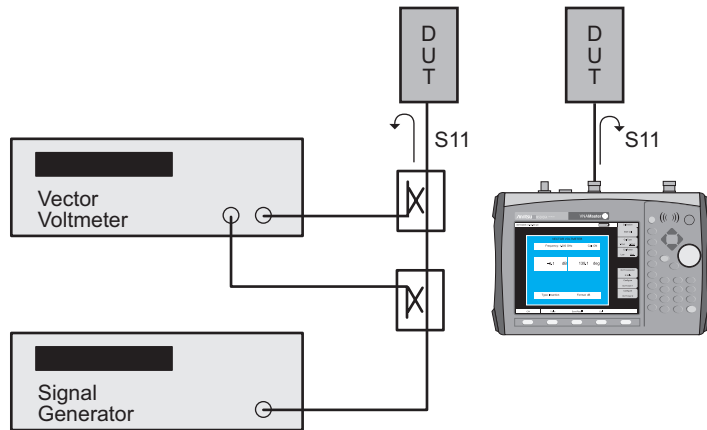

Compared to the Vector Voltmeter setup, this side-by-side illustration shows how VNA Master is a completely self-contained turnkey solution with integrated source, receivers, and couplers for phase matching cables.



High Accuracy Power Meter (Option 0019)

Conduct precise measurements of CW and digitally modulated transmitters in the field using this VNA Master software mode with a separately purchased Anritsu USB power sensor. These USB power sensors include the PSN50, MA24104A, MA24106A, MA24108A, and MA24118A. After specifying the center frequency and zeroing the sensor to ensure accuracy at low power levels, the software offers intuitive operation for absolute and relative readouts in dBm or Watts.

High Accuracy Power Meter provides true RMS measurements with a variety of USB power sensors to suit your needs.

GPS Receiver (Option 0031)

Built-in GPS provides location information (latitude, longitude, altitude) and Universal Time (UT) information for storage along with trace data so you can later verify that measurements were taken at the right location. The GPS option requires a separately ordered magnetic mount antenna (2000-1528-R) with a 15 foot (~ 5m) cable to mount outside on a metallic surface.

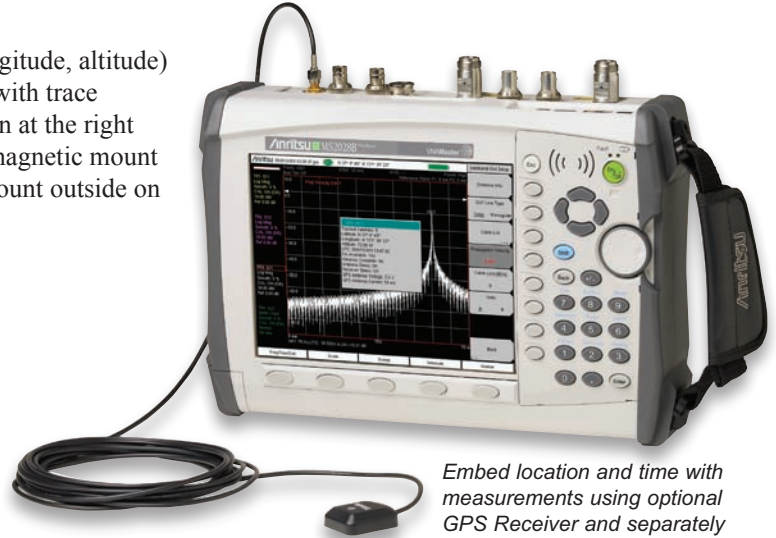

Embed location and time with measurements using optional GPS Receiver and separately ordered antenna (2000-1528-R).

Balanced/Differential S-Parameters, 1-port (Option 0077)

Verifying the performance and identifying discontinuities in differential cables is now possible with the VNA Master. After a full two-port calibration, connect your differential cable directly to the two test ports and reveal the S_{d1d1} performance, which is essentially differential return loss. With optional time domain, you can convert frequency sweeps to distance. This capability is especially valuable for applications in high data rate cables where balanced data formats are used to isolate noise and interference.

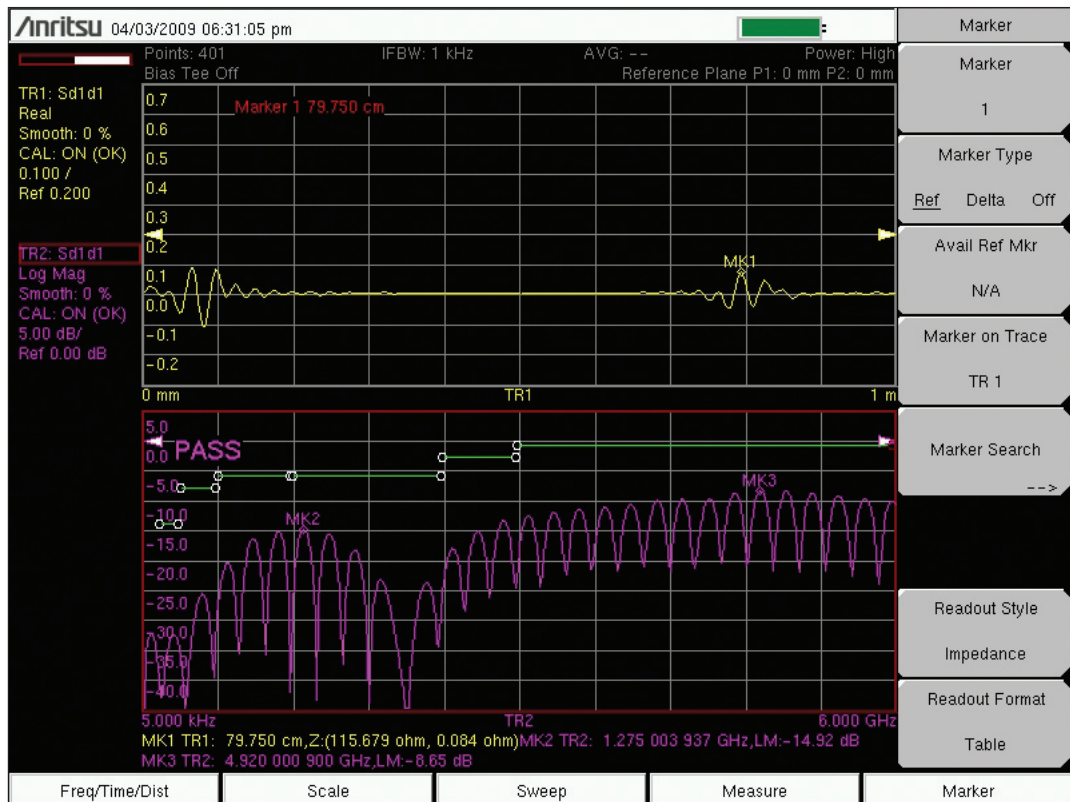

Use a full 2-port calibration to conduct one-port differential measurements of S_{d1d1} . Similar to other S-parameters, you can view S_{d1d1} in the frequency, time, or distance domain for signal integrity measurements anytime, anywhere.

Master Software Tools and Remote Programming

Each VNA Master ships with a versatile test assistant: a copy of Anritsu's Master Software Tools for Windows® 2000/XP/Vista. This allows an operator to add the processing capabilities of a PC and this software utility to the VNA Master to form a powerful and flexible measurement solution for network analysis. For automation, the VNA Master also supports remote programming via the Ethernet or USB interface.

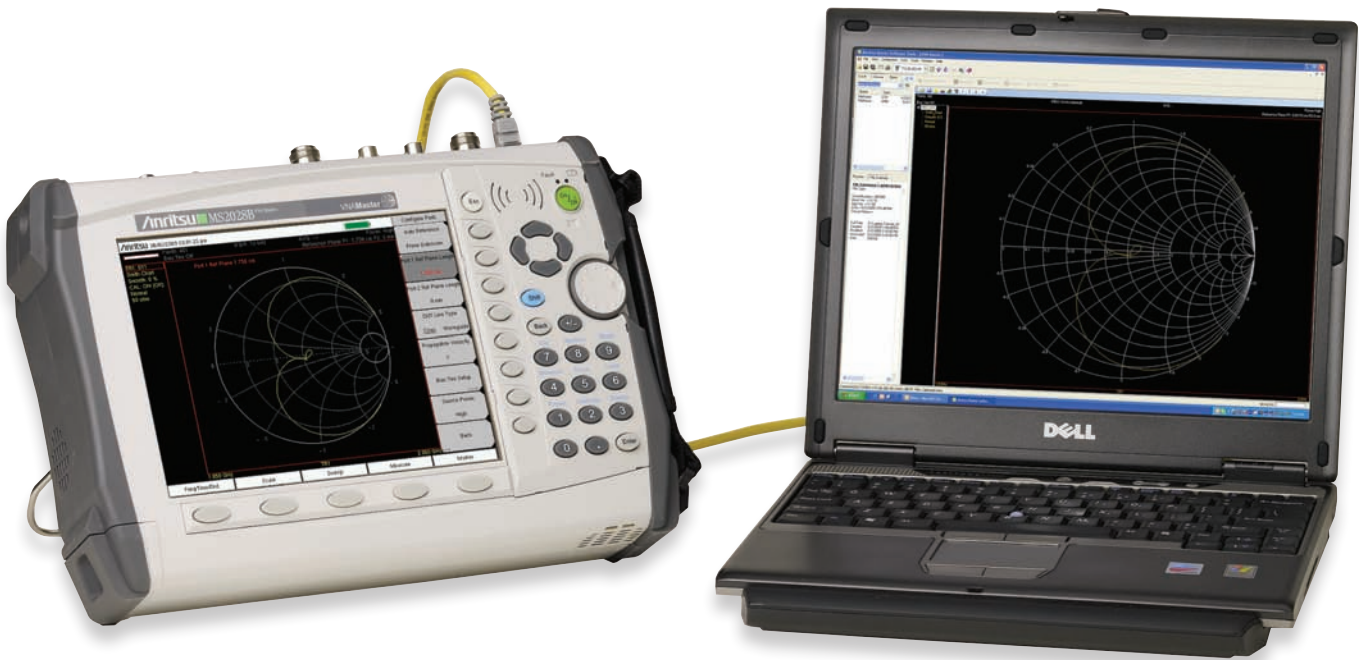

Connect VNA Master to a PC for archiving and additional post-processing. A standard tilt-bail provides convenient use on a bench.

Feature	Benefit
Powerful data management tool for storing and sifting through measurement results	MST simplifies transfers, printing, and archival of displays and setups
Connect to a PC using USB2.0 (full-speed), Ethernet LAN, or Direct Ethernet	Unleash powerful MST capabilities by using variety of popular remote interfaces
Store an unlimited number of setups, traces, and JPEGs (limited only by PC memory)	Develop libraries of frequently used setups and typical results
Manipulate traces and further optimize displays	Versatility to further analyze results without re-taking measurements
Update with the latest firmware	Easily download and upgrade to newest features from www.us.anritsu.com
Remote programming via Ethernet or USB	Increase throughput by automating repetitive or operator intensive tasks

Ordering Information

VNA Master™

MS2026B VNA Master, 2-port, 5 kHz to 6 GHz
MS2028B VNA Master, 2-port, 5 kHz to 20 GHz

The instrument includes standard one-year warranty and Certificate of Calibration and Conformance

MS2026B VNA Master Options

MS2026B-0002 Time Domain (includes DTF capability)
MS2026B-0005 Power Monitor (requires external detector)
MS2026B-0007 Secure Data Operation
MS2026B-0010 Built-in Bias-Tee
MS2026B-0015 Vector Voltmeter
MS2026B-0019 High Accuracy Power Meter (requires external USB sensor)
MS2026B-0031 GPS Receiver (requires GPS antenna, 2000-1528-R, sold separately)
MS2026B-0077 Balanced/Differential S-Parameters, 1-port
MS2026B-0098 Z-540 Calibration
MS2026B-0099 Premium Calibration

MS2028B VNA Master Options

MS2028B-0002 Time Domain (includes DTF capability)
MS2028B-0005 Power Monitor (requires external detector)
MS2028B-0007 Secure Data Operation
MS2028B-0010 Built-in Bias-Tee
MS2028B-0011 K(f) Test Port Connectors
MS2028B-0015 Vector Voltmeter
MS2028B-0019 High Accuracy Power Meter (requires external USB sensor)
MS2028B-0031 GPS Receiver (requires GPS antenna, 2000-1528-R, sold separately)
MS2028B-0077 Balanced/Differential S-Parameters, 1-port
MS2028B-0098 Z-540 Calibration
MS2028B-0099 Premium Calibration

MS202xB Standard Accessories

10580-00220 VNA Master User's Guide
65729 Soft Carrying Case
2300-498 Master Software Tools CD ROM
633-44 Rechargeable Battery, Li-Ion, 6.6 Ah
40-168-R AC-DC Adapter
806-141-R Automotive Cigarette Lighter 12 V DC adapter
3-2000-1498 USB A-to mini B cable, 3.05 m (10 ft.)
2000-1371-R Ethernet cable, 2.13 m (7 ft.)
3-806-152 Ethernet Crossover Cable, 2.13 m (7 ft.)
2000-1520-R USB Flash Drive

K Connector Components

OSLK50 Precision integrated Open/Short/Load K(m), DC to 20 GHz, 50 Ω
OSLK50 Precision integrated Open/Short/Load K(f), DC to 20 GHz, 50 Ω
22K50 Precision K(m) Short/Open, 40 GHz
22KF50 Precision K(f) Short/Open, 40 GHz
28K50 Precision Termination, DC to 40 GHz, 50 Ω, K(m)
28KF50 Precision Termination, DC to 40 GHz, 50 Ω, K(f)
3652A K Calibration Kit, DC to 40 GHz

N-Type Connectors

OSLN50 Precision Integrated Open/Short/Load N(m), DC to 18 GHz, 50 Ω
OSLNF50 Precision Integrated Open/Short/Load N(f), DC to 18 GHz, 50 Ω
22N50 Precision N(m) Short/Open, 18 GHz
22NF50 Precision N(f) Short/Open, 18 GHz
28N50-2 Precision Termination, DC to 18 GHz, 50 Ω, N(m)
28NF50-2 Precision Termination, DC to 18 GHz, 50 Ω, N(f)
OSLN50-1 Precision N(m) Open/Short/Load, 42 dB, 6 GHz
OSLNF50-1 Precision N(f) Open/Short/Load, 42 dB, 6 GHz
SM/PL-1 Precision N(m) Load, 42 dB, 6 GHz
SM/PLNF-1 Precision N(f) Load, 42 dB, 6 GHz

TNC Connector Components

1091-53-R Precision TNC(m) Open, 18 GHz, 50 Ω
1091-54-R Precision TNC(m) Short, 18 GHz, 50 Ω
1015-55-R Precision TNC(m) Load, 18 GHz, 50 Ω
1091-55-R Precision TNC(f) Open, 18 GHz, 50 Ω
1091-56-R Precision TNC(f) Short, 18 GHz, 50 Ω
1015-54-R Precision TNC(f) Load, 18 GHz, 50 Ω

7/16 Connector Components

2000-767-R Precision Open/Short/Load, 7/16(m), 4.0 GHz
2000-768-R Precision Open/Short/Load, 7/16(f), 4.0 GHz

Technical Data Sheet

10580-00501 VNA Master Technical Data Sheet

Manuals

10580-00220 VNA Master User's Guide
10580-00221 VNA Master Programming Manual

Related Literature, Application Notes

11410-00206 Time Domain for Vector Network Analyzers
11410-00214 Reflectometer Measurements – Revisited
11410-00270 What is Your Measurement Accuracy?
11410-00373 Distance-to-Fault
11410-00387 Primer on Vector Network Analysis
11410-00414 High Accuracy Power Meter, PSN50
11410-00424 USB Power Sensor MA24106A
11410-00483 Inline High Power Sensor MA24104A
11410-00504 Microwave USB Power Sensor MA241x8A



Anritsu Corporation

5-1-1 Onna, Atsugi-shi, Kanagawa, 243-8555 Japan
Phone: +81-46-223-1111
Fax: +81-46-296-1264

• U.S.A.

Anritsu Company

1155 East Collins Boulevard, Suite 100,
Richardson, Texas 75081 U.S.A.
Toll Free: 1-800-ANRITSU (267-4878)
Phone: +1-972-644-1777
Fax: +1-972-671-1877

• Canada

Anritsu Electronics Ltd.

700 Silver Seven Road, Suite 120, Kanata,
Ontario K2V 1C3, Canada
Phone: +1-613-591-2003
Fax: +1-613-591-1006

• Brazil

Anritsu Eletrônica Ltda.

Praca Amadeu Amaral, 27-1 Andar
01327-010 - Paraíso, São Paulo, Brazil
Phone: +55-11-3283-2511
Fax: +55-11-3886940

• Mexico

Anritsu Company, S.A. de C.V.

Av. Ejército Nacional No. 579 Piso 9, Col. Granada
11520 México, D.F., México
Phone: +52-55-1101-2370
Fax: +52-55-5254-3147

• U.K.

Anritsu EMEA Ltd.

200 Capability Green, Luton, Bedfordshire LU1 3LU, U.K.
Phone: +44-1582-433280
Fax: +44-1582-731303

• France

Anritsu S.A.

16/18 Avenue du Québec-SILIC 720
91961 COURTABOEUF CEDEX, France
Phone: +33-1-60-92-15-50
Fax: +33-1-64-46-10-65

• Germany

Anritsu GmbH

Nemetschek Haus, Konrad-Zuse-Platz 1
81829 München, Germany
Phone: +49 (0) 89 442308-0
Fax: +49 (0) 89 442308-55

• Italy

Anritsu S.p.A.

Via Elio Vittorini, 129, 00144 Roma, Italy
Phone: +39-06-509-9711
Fax: +39-06-502-2425

• Sweden

Anritsu AB

Borgarfjordsgatan 13, 164 40 Kista, Sweden
Phone: +46-8-534-707-00
Fax: +46-8-534-707-30

• Finland

Anritsu AB

Teknobulevardi 3-5, FI-01530 Vantaa, Finland
Phone: +358-20-741-8100
Fax: +358-20-741-8111

• Denmark

Anritsu A/S

Kirkebjerg Allé 90 DK-2605 Brøndby, Denmark
Phone: +45-72112200
Fax: +45-72112210

• Spain

Anritsu EMEA Ltd.

Oficina de Representación en España

Edificio Veganova
Avda de la Vega, n° 1 (edf 8, pl1, of 8)
28108 ALCOBENDAS - Madrid, Spain
Phone: +34-914905761
Fax: +34-914905762

• Russia

Anritsu EMEA Ltd.

Representation Office in Russia

Tverskaya str. 16/2, bld. 1, 7th floor.
Russia, 125009, Moscow
Phone: +7-495-363-1694
Fax: +7-495-935-8962

• United Arab Emirates

Anritsu EMEA Ltd.

Dubai Liaison Office

P O Box 500413 - Dubai Internet City
Al Thuraya Building, Tower 1, Suite 701, 7th Floor
Dubai, United Arab Emirates
Phone: +971-4-3670352
Fax: +971-4-3688460

• Singapore

Anritsu Pte. Ltd.

60 Alexandra Terrace, #02-08, The Comtech (Lobby A)
Singapore 118502
Phone: +65-6282-2400
Fax: +65-6282-2533

• India

Anritsu Pte. Ltd.

India Branch Office

3rd Floor, Shri Lakshminarayan Niwas,
#2726, 80 ft Road, HAL 3rd Stage, Bangalore - 560 075, India
Phone: +91-80-4058-1300
Fax: +91-80-4058-1301

• P. R. China (Hong Kong)

Anritsu Company Ltd.

Units 4 & 5, 28th Floor, Greenfield Tower, Concordia Plaza,
No. 1 Science Museum Road, Tsim Sha Tsui East,
Kowloon, Hong Kong, P.R. China
Phone: +852-2301-4980
Fax: +852-2301-3545

• P. R. China (Beijing)

Anritsu Company Ltd.

Beijing Representative Office

Room 2008, Beijing Fortune Building,
No. 5, Dong-San-Huan Bei Road,
Chao-Yang District, Beijing 100004, P.R. China
Phone: +86-10-6590-9230
Fax: +86-10-6590-9235

• Korea

Anritsu Corporation, Ltd.

8F Hyunjuk Bldg. 832-41, Yeoksam-Dong,
Kangnam-ku, Seoul, 135-080, Korea
Phone: +82-2-553-6603
Fax: +82-2-553-6604

• Australia

Anritsu Pty Ltd.

Unit 21/270 Ferntree Gully Road, Notting Hill
Victoria, 3168, Australia
Phone: +61-3-9558-8177
Fax: +61-3-9558-8255

• Taiwan

Anritsu Company Inc.

7F, No. 316, Sec. 1, Neihu Rd., Taipei 114, Taiwan
Phone: +886-2-8751-1816
Fax: +886-2-8751-1817

Please Contact:

